



OLIVARI :

Guilloché

dodáva AROSE s.r.o.

## alfabetico/name

pag. **modello/model** cod.

12	<b>Atena Ligne</b>	<b>B</b>	<input type="radio"/>	1AL
16	<b>Atena Panier</b>	<b>B</b>	<input type="radio"/>	1AP
14	<b>Atena Rank</b>	<b>B</b>	<input type="radio"/>	1AR
6	<b>Diana Barley</b>	<b>B</b>	<input type="checkbox"/>	1DB
10	<b>Diana Chevron</b>	<b>B</b>	<input type="checkbox"/>	1DC
8	<b>Diana Damier</b>	<b>B</b>	<input type="checkbox"/>	1DD

## disegni tecnici/technical drawings

pag. 20

Olivari  
maniglie  
made  
in Italy  
dal 1911

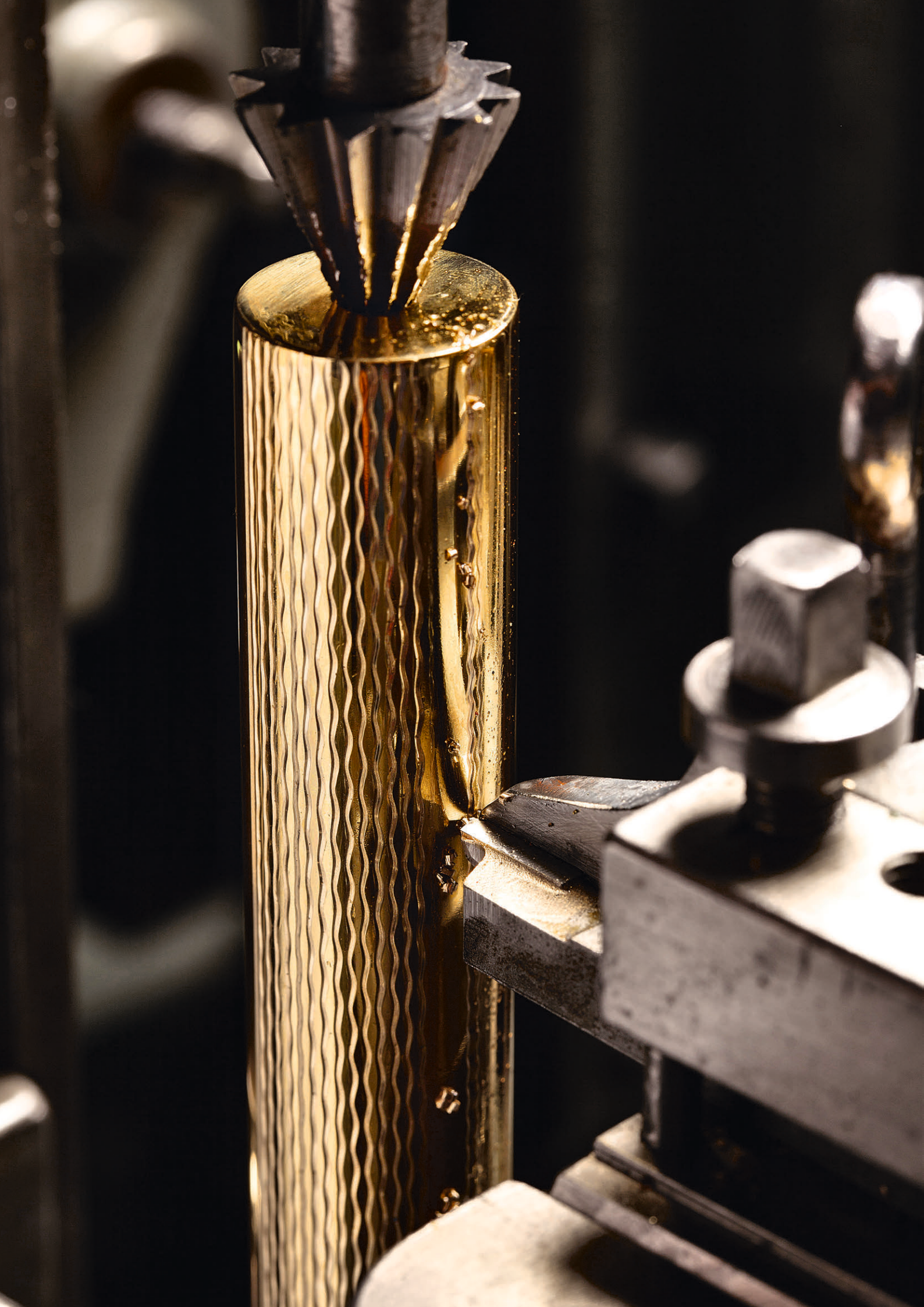



# guilloché

Il guilloché è una tecnica decorativa di incisione realizzata con apposite macchine che, guidate manualmente, generano un preciso, intricato e ripetitivo pattern sul materiale di base. A differenza dell'incisione *tout court*, realizzata a mano, che si presta a un decoro più libero e naturalistico, quella realizzata con le macchine à guillocher è tipicamente meccanica e ripetitiva, consente però di ottenere un'infinità di pattern differenti al variare dei parametri di lavorazione combinandosi alla sensibilità tecnica, ma anche estetica, dell'operatore. L'origine esatta delle prime macchine non è nota con certezza. È possibile che abbiano paternità svizzera, forse per opera di un ingegnere francese di nome Guillot. I primi esempi di casse di orologio lavorate con questa tecnica portano inciso l'anno 1624. L'effettiva introduzione nel settore dell'orologeria risale al 1786, quando Abraham-Louis Breguet inizia a utilizzarla per decorare i quadranti e le casse dei suoi orologi. Questa tecnica sperimenta una straordinaria popolarità nel XIX secolo, grazie soprattutto all'opera di Peter Carl Fabergé.

Guilloché is a decorative engraving technique that uses special lathes. Guided manually, these machines draw a precise, intricate, repeated pattern on the metal surface. Different to freehand engraving, which is suited to more naturalistic and free decorations, guilloché engraving is typically mechanical and reiterative. It allows for infinite different patterns by varying the parameters of the process, which work in concert with the technician's technical sensibility and aesthetic judgement. The exact origin of the first guilloché machines is uncertain, but perhaps they were Swiss or invented by a French engineer named Guillot. The first examples of its use are found on watch cases engraved with the year 1624. The definitive introduction of guilloché in watchmaking dates back to 1786, when Abraham-Louis Breguet began using it to decorate the dials and cases of his watches. In the 19<sup>th</sup> century, the technique became highly popular, largely thanks to the work of Peter Carl Fabergé.

# Diana Barley Studio Olivari 2016

M1DBB



CR Cromo lucido/Bright chrome



NL SuperNichel lucido/  
SuperNickel bright



ZL SuperOro lucido/  
SuperGold bright

C1DB



K1DBB



**BARLEY "A CHICCO D'ORZO", ALLURE BRILLANTE E SOFISTICATA.**  
La decorazione Barley riprende il classico motivo "a chicco d'orzo" della tradizione guilloché: la trama di fitte incisioni che si rincorrono conferisce alla maniglia un'allure brillante e sofisticata.

**ENGRAVING SIMILAR TO GRAINS OF BARLEY WITH A SHINY SOPHISTICATED ALLURE.**

The Barley decoration is based on the classic grain motif of traditional guilloché engraving. The running, close-set pattern gives the handle shiny, sophisticated allure.

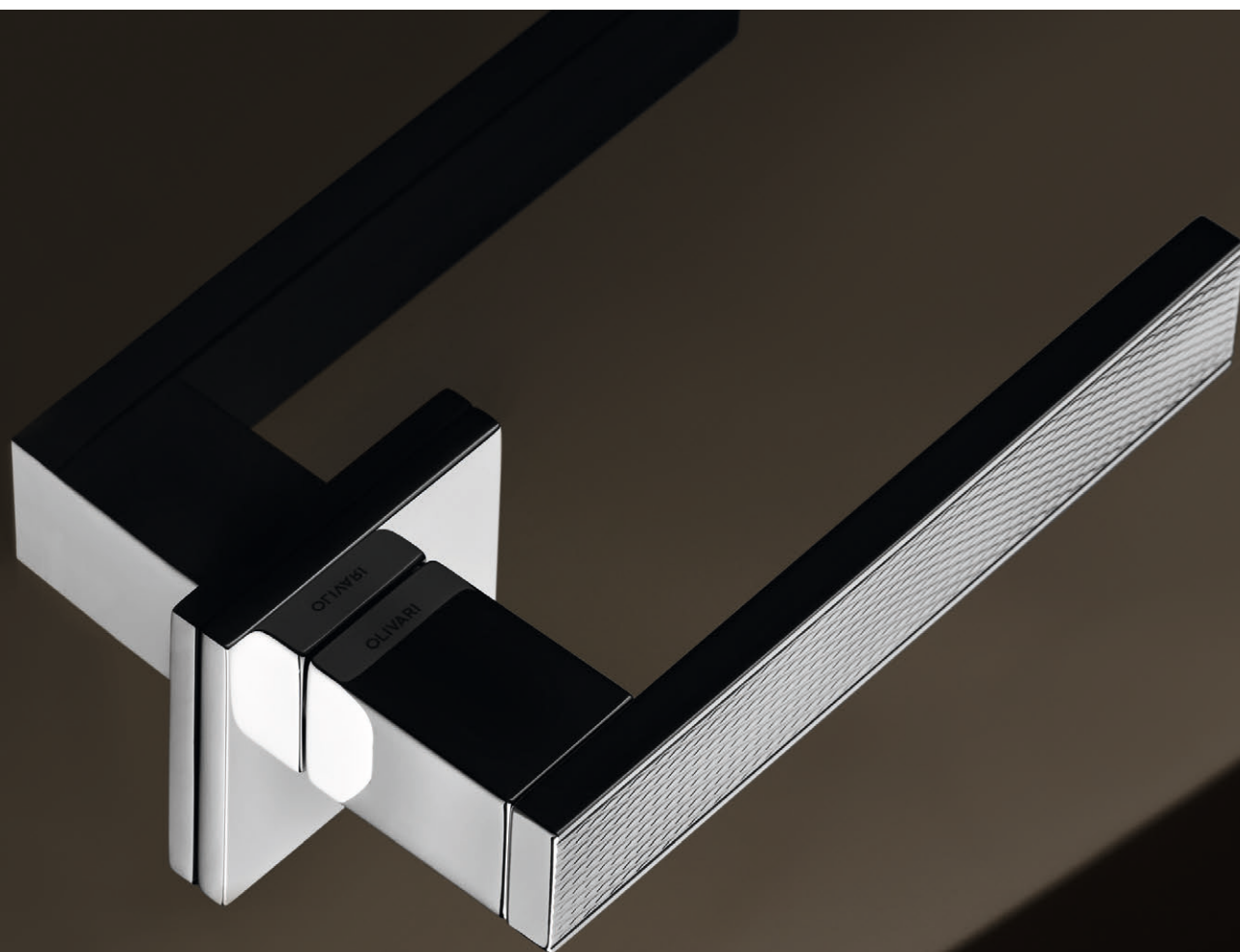

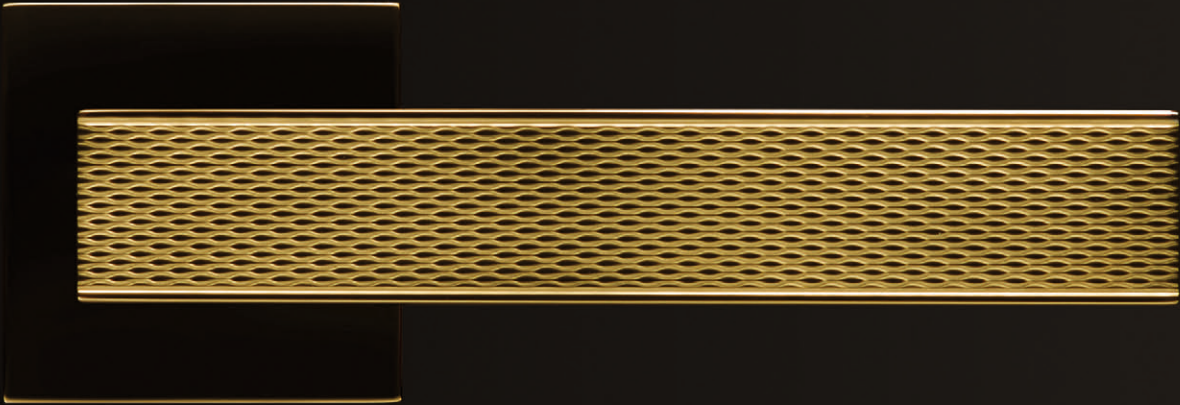
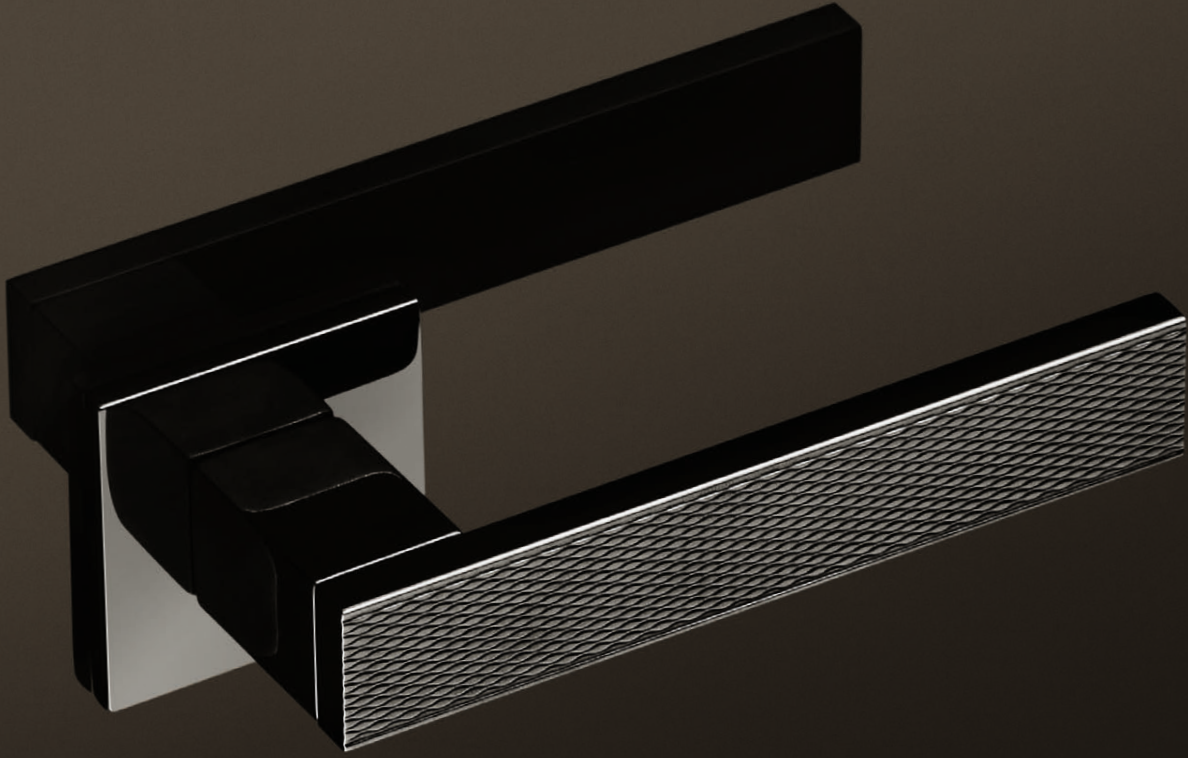



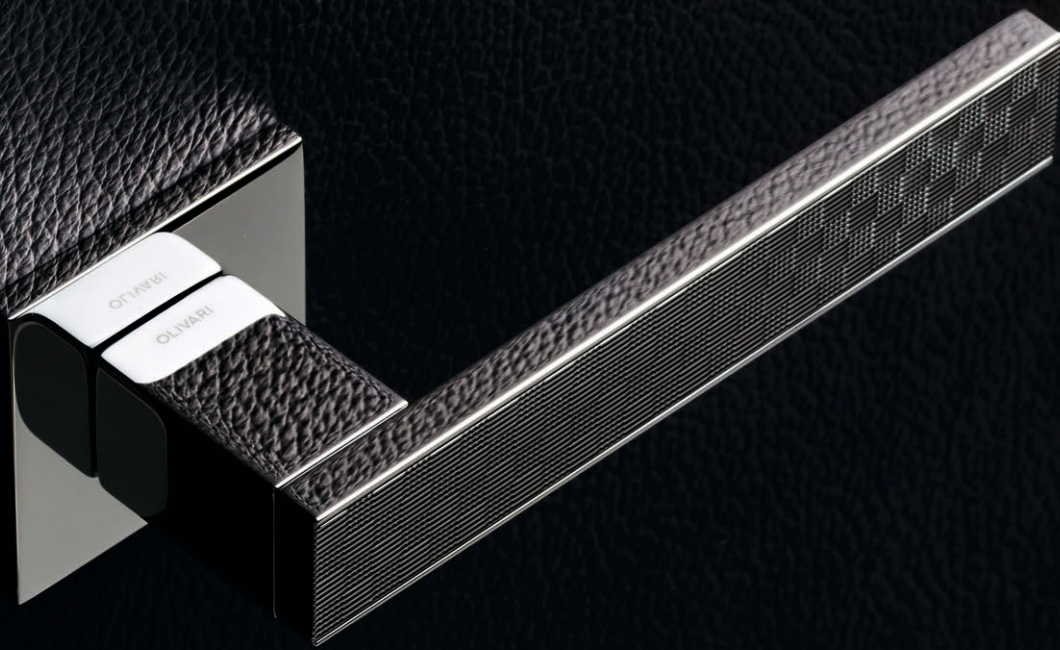

# Diana Damier Studio Olivari 2016

M1DDB



CR Cromo lucido/Bright chrome



NL SuperNichel lucido/  
SuperNickel bright



ZL SuperOro lucido/  
SuperGold bright

C1DD



K1DDB



**DAMIER "A SCACCHI", CARATTERI DI UN'ELEGANZA SOFISTICATA.**  
La decorazione Damier riprende il classico motivo "a scacchi" della tradizione guilloché: la trama di fitte incisioni alternate esprime i caratteri di un'eleganza sofisticata.

**ELEGANT CHEQUERS WITH A SOPHISTICATED AIR.**  
The Damier decoration takes up the classic chequerboard motif of traditional guilloché engraving with alternating squares of close-set patterns of sophisticated elegance.







# Diana Chevron

Studio Olivari 2016

M1DCB



CR Cromo lucido/Bright chrome



NL SuperNichel lucido/  
SuperNickel bright

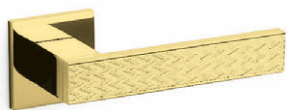

ZL SuperOro lucido/  
SuperGold bright

C1DC



K1DCB



**CHEVRON "A ZIG-ZAG" O "SPINA DI PESCE", ESPRESSIONE DI PREZIOSITÀ E RAFFINATEZZA.**

La decorazione Chevron riprende il classico motivo "a zig-zag", o a "spina di pesce", della tradizione guilloché, espressione di preziosità e raffinatezza.

**A HERRINGBONE MOTIF EXPRESSING PRECIOUS REFINEMENT.**  
The Chevron decoration takes up the classic herringbone motif of traditional guilloché engraving as an expression of preciousness and refinement.

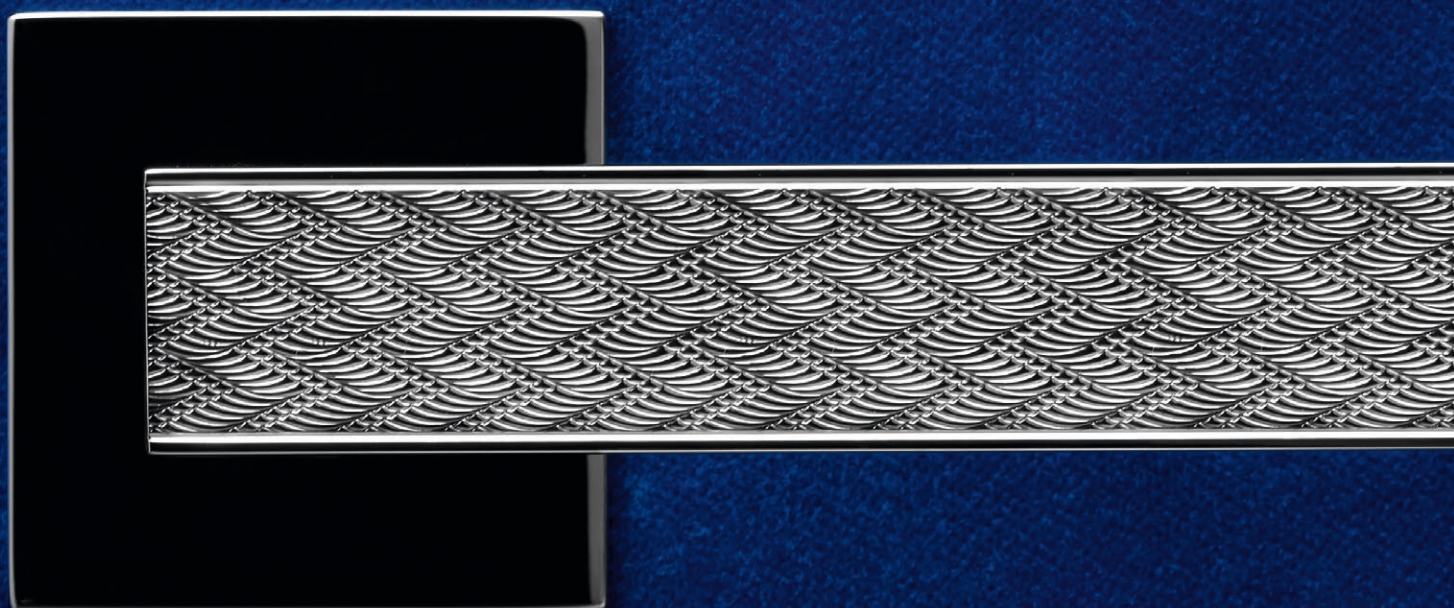



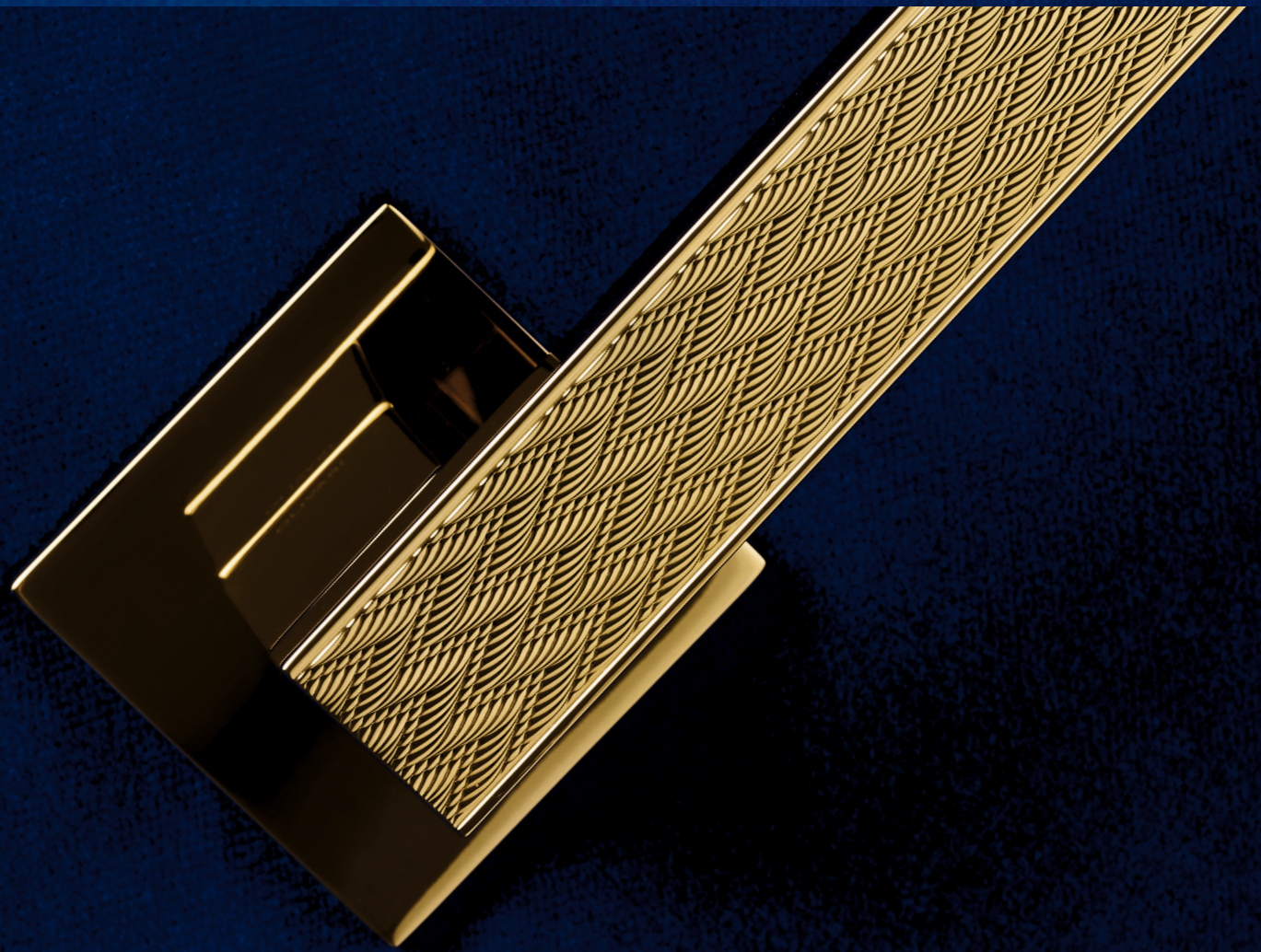



# Atena Ligne Studio Olivari 2016

M1ALB



CR Cromo lucido/Bright chrome



NL SuperNichel lucido/  
SuperNickel bright



ZL SuperOro lucido/  
SuperGold bright

C1AL



K1ALB



**LIGNE "A RIGHE", ELEGANZA ESSENZIALE E SENZA TEMPO.**

La decorazione Ligne sposa il classico motivo "a righe" della tradizione guilloché con la perfetta geometria cilindrica della maniglia per una soluzione di eleganza essenziale e senza tempo.

**AN ELEGANT LINEAR PATTERN, TIMELESS AND UNDERSTATED.**

The Ligne decoration marries the classic lined motif of traditional guilloché engraving with the perfect cylindrical geometry of the handle, resulting in understated, timeless elegance.

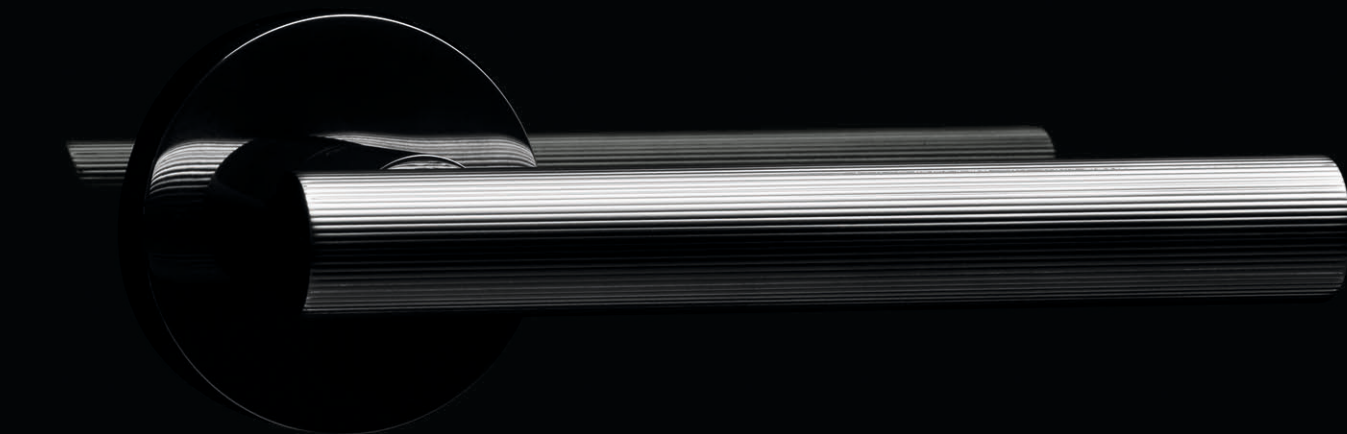







# Atena Rank Studio Olivari 2016

M1ARB



CR Cromo lucido / Bright chrome



NL SuperNichel lucido /  
SuperNickel bright



ZL SuperOro lucido /  
SuperGold bright

C1AR



K1ARB



**RANK "A ONDA", RIFLESSI DI FORTE CARATTERE.**

La decorazione Rank riprende il classico motivo "a onda" della tradizione guilloché che ben si sposa con la purezza geometrica del cilindro creando riflessi di forte carattere.

**WAVY ZIGZAGS FOR CHARACTERFUL REFLECTIONS.**

The Rank decoration takes up the classic wavy zigzag motif of traditional guilloché engraving, which lends itself perfectly to the geometrical pureness of the cylinder, creating characterful reflections.







# Atena Panier Studio Olivari 2016

M1APB



CR Cromo lucido/Bright chrome



NL SuperNickel lucido/  
SuperNickel bright



ZL SuperOro lucido/  
SuperGold bright

C1AP



K1APB



**PANIER, INTRECCIO DI VIMINI DELLE CESTE, ELEGANZA E CLASSICITÀ.**  
La decorazione Panier riprende il classico motivo della tradizione guilloché che allude all'intreccio di vimini delle ceste, esprimendo eleganza e classicità.

**A BASKET-WEAVE PATTERN WITH CLASSIC ELEGANCE.**  
The Panier decoration takes up the classic basket-weave motif of traditional guilloché engraving to express elegance and classicism.









# disegni tecnici

technical drawings

### Atena Ligne M1AL (p.12)

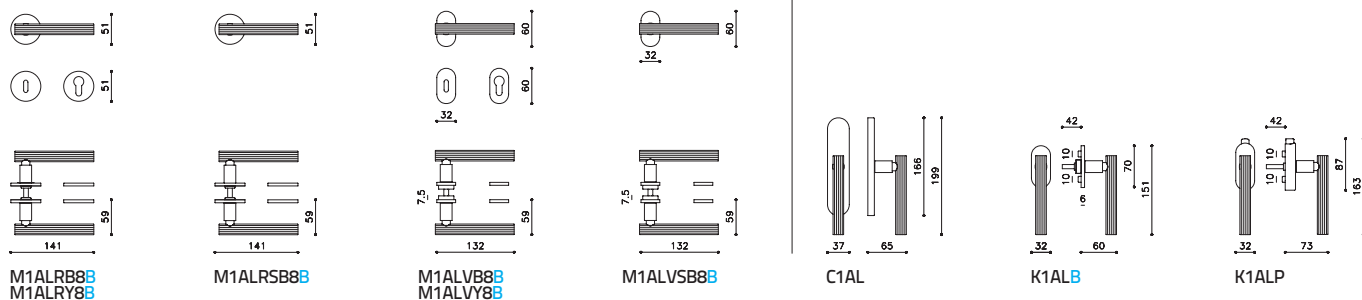

### Atena Panier M1AP (p.16)

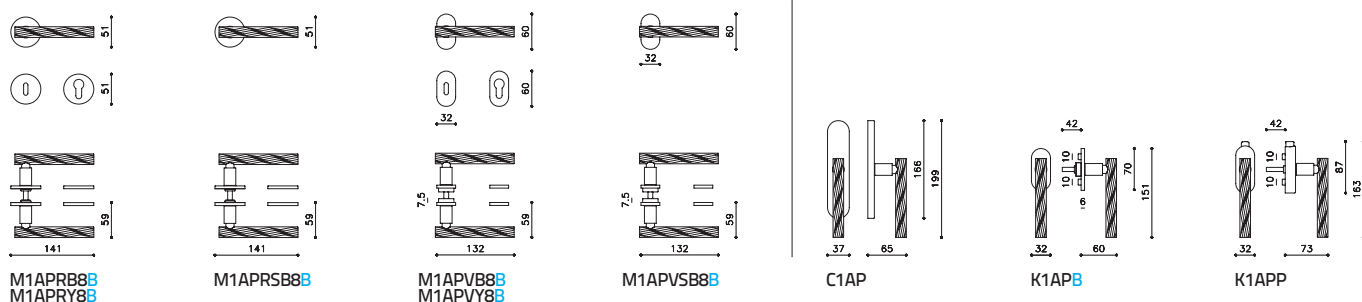

### Atena Rank M1AR (p.14)

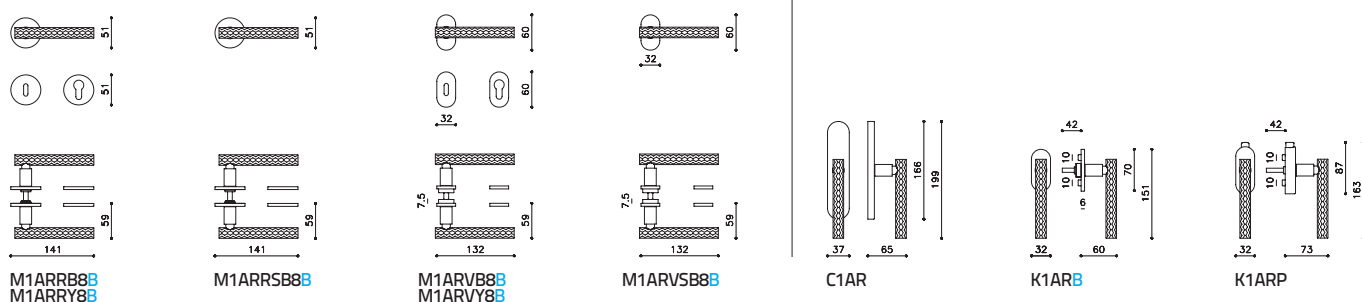



### Diana Barley M1DB (p.6)

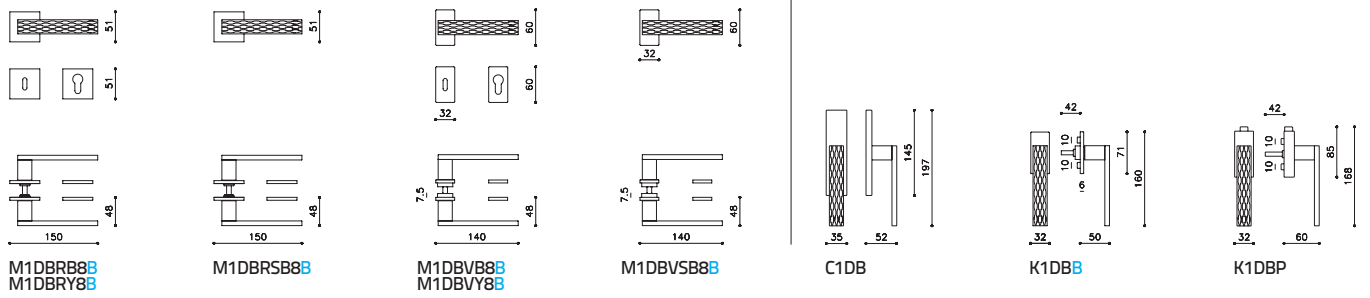

### Diana Chevron M1DC (p.10)

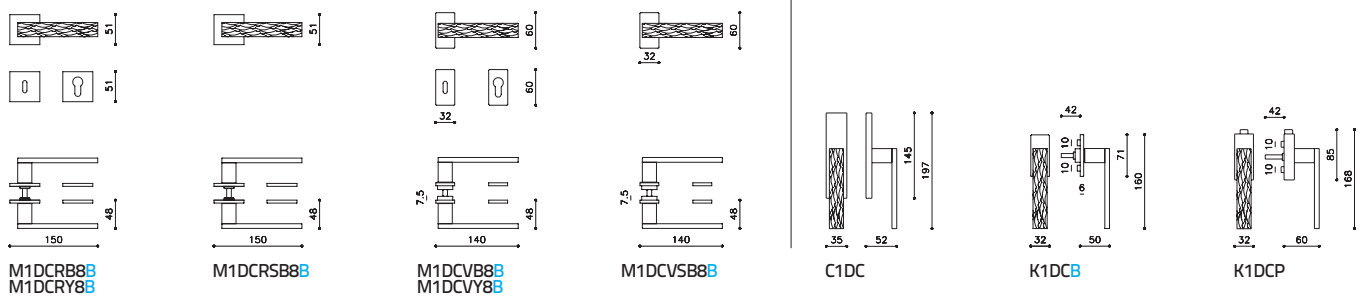

### Diana Damier M1DD (p.8)

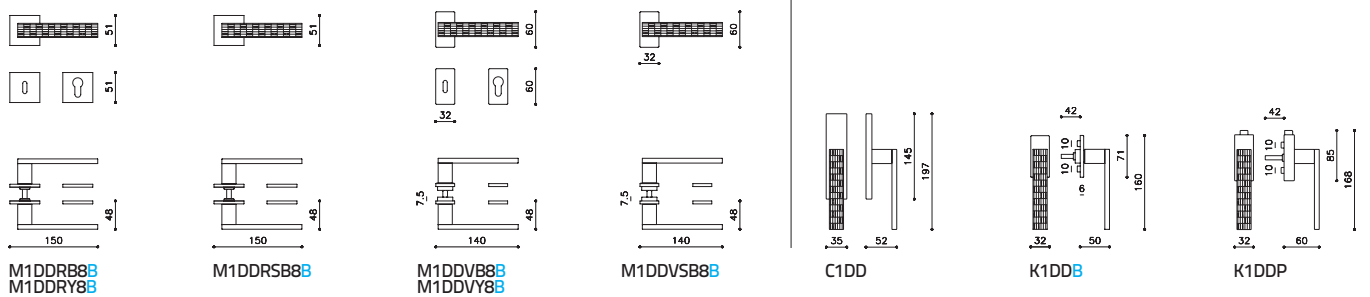

Il catalogo ed i prodotti sono soggetti ad aggiornamenti.  
Modelli e marchi depositati.

Tutti i diritti riservati © Olivari B. s.p.a.

Catalog and products subject to updating.  
Registered trademarks and patented designs.  
All rights reserved © Olivari B. s.p.a.

I prodotti OLIVARI sono soggetti a tutela brevettuale, in Italia, in Europa e in molti paesi del mondo. A volte sono oggetto di contraffazioni da parte di terzi, che ne riproducono forma e dimensioni in maniera quasi identica. Invitiamo i clienti a diffidare da chi offre prodotti "tipo OLIVARI" e ad acquistare solo i prodotti originali "OLIVARI".

OLIVARI products are registered and patented in Italy, Europe and many countries around the world. Sometimes they are counterfeited by third party, which reproduce shape and size almost identically. We invite our customers to be wary of those who offers "OLIVARI like" products and buy only the original "OLIVARI" products.

**Olivari B. spa**

Via Giacomo Matteotti, 140  
28021 Borgomanero NO Italy  
T +39 0322 835080  
F +39 0322 846484  
olivari@olivari.it  
www.olivari.it





olivari.it

arose.sk